

Thanks for buying the CZH-T200 portable FM transmitter.

Before you use this transmitter at the first time, please read the user manual carefully and operate the device following the instructions. It is multi-functional device but easy to operate. We sincerely hope our products will bring you happy experience.

CZH-T200 Portable FM Transmitter User Manual



Please read this manual before you use the device, restore the manual carefully in case you'll need it in the future.

Copyright

This manual belongs to our company only, we reserve all right. This manual is subject to change without notice. Without the permission of the our company, it shall not be copied,transmitted or translated to any language or computer language.

1. Attention before use

- 1) Only professional engineer can do the repair work.
- 2) Don't power on the transmitter without connecting the antenna.
- 3) Don't use the transmitter in explosive environment.(such as gas station,natural gas or steam)
- 4) Don't put the transmitter in extreme dusty,damp or hot places.
- 5) Please use the transmitter following the local regulations.
- 6) Please try not to use the transmitter in thunder/storm weather.

2. Main Characteristics:

- 1) This transmitter uses professional transmitting transistors, it gives excellent audio quality,the audio port and microphone port are independent from each other, the input siganl will be processed independently too, this decrease the loss of sound quality in a large extent.
- 2) The Power output is 4 levels adjustable, choose different power in different situation can avoid intereference to the environment around.
- 3) This transmitter is equipped with special antenna, it is stable and reliable in transmitting a relative far range.
- 4) This transmitter uses 1000ma li-on battery, its high capacity enables a long working time up to 16hours at the lowest power output mode.
- 5) The noise and harmonics are 60dB, acheiveing professional standard. This can avoid the interference to surround environment.
- 6) MONO/STEREO adjutable, easy to use.

3. Application Area

Driving school teaching	Campus teaching
Stage directing	Public speech
Tourism guide	CAR walkie talkie,MP3 audio transmision
HOME wirelss audio system	Wireless meeting system
Spontaneous translatioin	Outdoor camping

CZH-T200 FM Transmitter Application Areas



4. Operation Instruction:

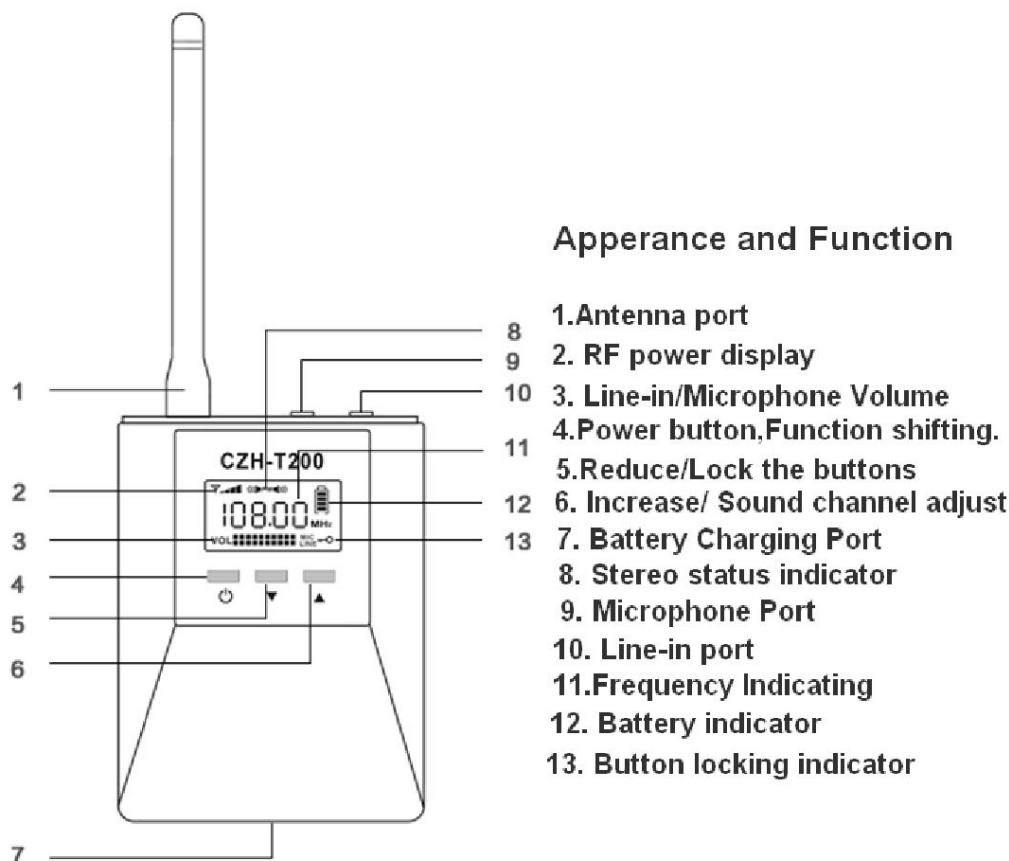

1). Battery cover Install/removing:

A. Install the battery cover by inserting its legs to the holes on the back of transmitter, then push in(Picture A), and Press until it's locked tightly(Picture B).

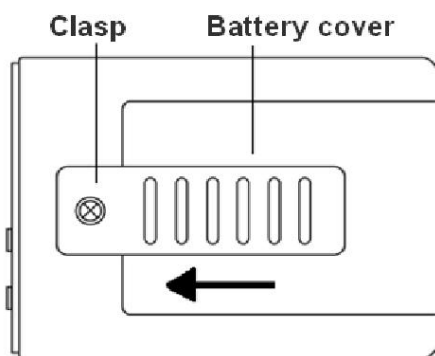

(Picture A)

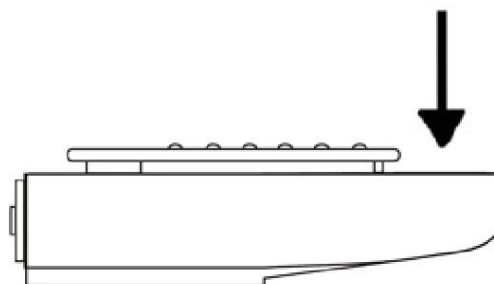

(Picture B)

B. Hold the back of the cover and open it a little(Picture C), then pull out the cover from the slot(Picture D).

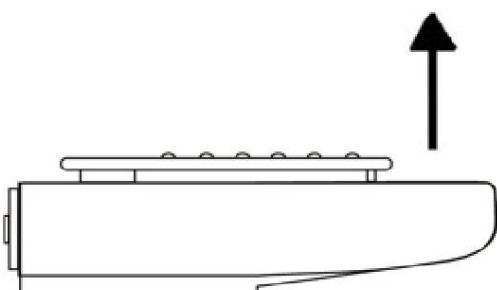

(Picture C)

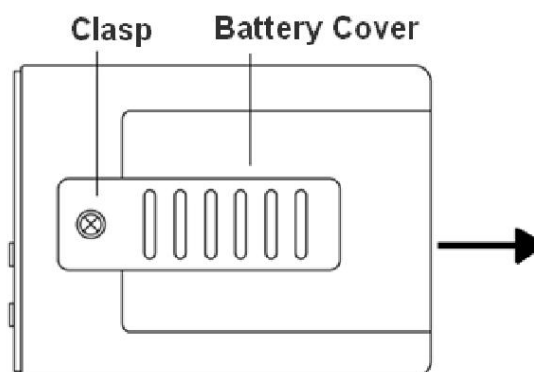

(Picture D)

2). Antenna Install/Uninstall (This is anti-screw diirection antenna)

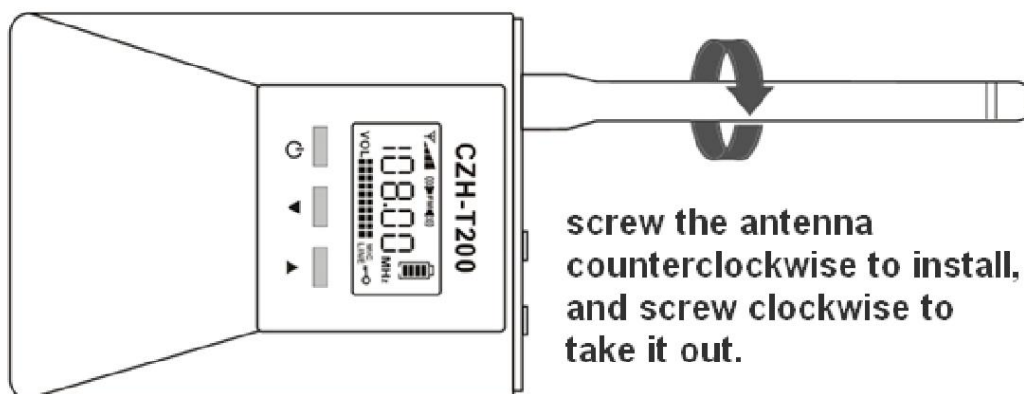

3). Power ON/OFF

A. When the transmitter is OFF,press and hold 【⏻】 to power on.

B. When the transmitter is in working status, press and hold 【⏻】 to power off.



4) Microphone Volume Setting

Press【】,the MIC icon starts flashing,press【】 to reduce the volume and press【】to increase.





5) Line-in Volume Setting

Press 【】 , the“LINE” icon starts flashing, press 【】 to reduce the volumeand press 【】 to increase.



6) Frequency Setting



Press 【】 , The“MHz” icon starts flashing, press 【】 to turn down frequency, and press 【】 to turn up.

7) RF Power Setting



Press 【】 , the“” icon starts flashing, press 【】 to reduce the broadcasting power and press 【】 to increase.

8) Button lock/unlock function

A.Under normal working status, press and hold 【】 , the screen will show【】 which means the other buttons are all locked.

B. Under button locking status, press and hold 【】 ,the screen will show 【】 which means the buttons are unlocked.

9) Stereo/Mono adjustment

Under normal working status, press and hold【】to shift between stereo/mono, when the screen shows 【】 ,it means the current sound mode is Stereo. When the screen doesn't show 【】 ,it means the current sound mode is Mono.

10) Battey charing

(1) Connect the battery charger(DC5V) with transmitter via the USB line, the icon 【】 starts flashing, the battery begins charging.

(2) When battery is full after charge, the 【】 icon will stop flashing. Usually it's about 5hours to charge battery full.

11) Reminder: Battery charing can be done no matter the transmitter is ON or OFF. Please kindly note the following items:

A、 When the icon 【】 shows empty,it means battery is low and needs to charge as soon as possible.

B、 When charing battery as transmitter is ON, the transmitting power will be automatically shifted to the minimum level,this is a normal phenomenon.

C、 When charing battery as transmitter is OFF, there is nothing showing on the screen.

D、 When the transmitter is vacant for a long time, please take the battery out and put it in cool and dry environment.

5.Main Specifications:

No.	Item	Specification
1	Power supply	BL - 5C li-on battery, 3.7V 1000mAh

2	Frequency range	87~108MHz / 76~90MHz (optional)
3	Frequency Stability	±10PPM
4	Frequency stepping	100KHz
5	RF power output	(Level 1/2 /3/4) 0.01mW-10mW-100mW-200mW
6	Broadcasting range for reference	(Level 1/2 /3/4) 10m-100m-300m-500m
7	Working time	(Level 1/2 /3/4) 16h-10h-8h-6h
8	Battery Charing time	About 5hours, voltage is 5V.
9	Spurious,harmonic radiation	- 60dB
10	Sound distortion	0.2%
11	Frequency response	50Hz~15000Hz
12	Input level	- 15 dBV
13	Frequency Modulation	±75KHZ
14	SNR	60 dB
15	Device Size	82*60*22mm (extrudding part not included)
16	Weight	About 67g(Battery not included)

6.All configurations

NO.	Item	Product Name	Description	Quantity	Unit
1	Standard configuration	Tranmsitter	CZH-T200	1	pcs
2		FM antenna	Anti-screw direction	1	pcs
3		Li-on battery	BL-5C 1000mAh	1	pcs
4		Car charger	With IC protection, Output voltage : DC 5V 1000mA	1	pcs
5		Lavalier microphone	Stereo,gold plating,1.2meters with shielding function.	1	pcs
6		Audio cable	3.5 male to male	1	pcs
7		USB cable	USB to T Port (MINI)	1	pcs
8		Packing box	Color box neutural packing	1	pcs
9	Optional accessories	USB charger	With IC protection Output voltage : DC 5V 500mA	1	pcs
10		Headphone micropohne	Stereo,1.2m cable	1	pcs

7. After-sales Service :

Thank you for choosing our product, we'll provide lifetime maintenance. Within 200days after purchasing, we provide all-free repairing. The following circumstance are excluded:

- 1). Problems caused by unauthorized disassembling or repairing on the product.
- 2). Problems caused by mis-opeartion without following the instruction.
- 3). Problems caused by man-made damage/hit/crash/water and other non-product quality problems.
- 4). The product being damaged by Thunder or other force majeure.
- 5). Product case, li-on battery,microphone,charger, audio cable,charging cable and othe accessories are not in free repairing range.

For products over or not belonging to the free-repairing period,we can provide repairing with very low cost.

- 1) We provide lifetime miantenance for product over the free-repairing period.
- 2) We can repair the products that over the free-repairing period or damaged manmade with very low cost.

8. Disclaimer

Please use this product following local laws or regualtions about using wireless products, otherwise the user will be responsible for any problems occured by not obeying rules. We and our distributors are free of responsibility for that.

CZH-T200 Customer Feedback Card

If you are satisfied with our product, we'll highly appreciate if you can kindly refer to your friends of our prouducts.

If you are not satisfied with our product, please kindly let use know what we can do to help, we'll be glad to improve per customer's needs to acheive full satisfaction.

Thanks for your letter!

Your advices:

Warranty Service Card

Distributor Name			
Distributor Website			
E-shopping ID	Purchase Date	Customer Name	Contact Number
Customer Shipping Address			
Product problem description:			

Remark: Please fill in this card carefully for the sake of we sending it back to you in time, the characters should be recognizable and clear. The problem description should be as detailed as possible as we can find out the solution quickly.